

**Whirlpool**

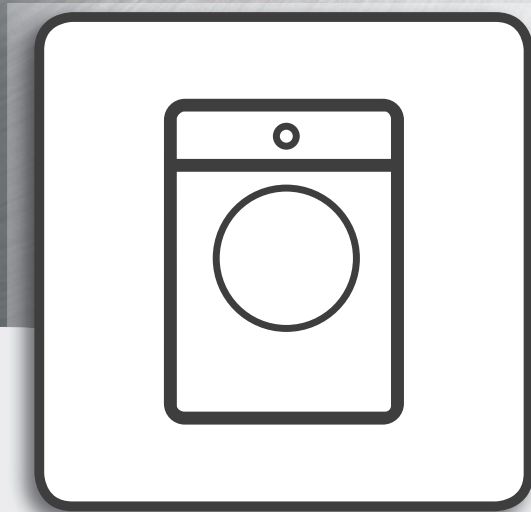

**Health & Safety, Use & Care, Installation Guide**

**Front Load Washer & Dryer**

**Model:**

WWEB9602IG

# USER MANUAL



THANK YOU FOR BUYING A WHIRLPOOL PRODUCT.



Read operator's manual



ISO 7010 W021 : Risk of fire/flammable materials

- Oil-affected items can ignite spontaneously, especially when exposed to heat sources such as in a tumble dryer. The items become warm, causing an oxidation reaction in the oil. Oxidation creates heat. If the heat cannot escape, the items can become hot enough to catch fire. Piling, stacking or storing oil affected items can prevent heat from escaping and so create a fire hazard. If it is unavoidable that fabrics that contain vegetable or cooking oil or have been contaminated by hair care products be placed in a tumble dryer they should first be washed in hot water with extra detergent - this will reduce, but not eliminate, the hazard.

## INDEX

<b>HEALTH &amp; SAFETY GUIDE</b> .....	<b>3</b>
<b>Safety Instructions</b> .....	<b>3</b>
<b>USER MANUAL</b> .....	<b>4</b>
Installation instructions.....	4
Specification Sheet .....	5
<b>Product description</b> .....	<b>6</b>
Detergent dispenser .....	6
Technical data for water connection .....	6
Control panel .....	7
Programmes .....	7
Options & Functions.....	8
Programme chart .....	9
Door.....	9
Accessories .....	10
<b>How to use the appliance</b> .....	<b>10</b>
First time use .....	10
Daily use.....	10
Matters need attention .....	11
Indicators.....	12
Hints and tips.....	12
<b>Cleaning &amp; maintenance</b> .....	<b>13</b>
Cleaning the outside of the washing machine.....	13
Checking the water supply hose.....	13
Cleaning the mesh filters in the water supply hose .....	14
Cleaning the detergent dispenser .....	14
Cleaning the water filter / draining residual water.....	15
<b>Troubleshooting</b> .....	<b>16</b>
Door – how to open it in case of a failure, to take out your laundry.....	17
Transport and handling .....	17
<b>After-sales service</b> .....	<b>18</b>

## SAFETY INSTRUCTIONS

## IMPORTANT TO BE READ AND OBSERVED

Before using the appliance, read these safety instructions. Keep them nearby for future reference. These instructions and the appliance itself provide important safety warnings, to be observed at all times. The manufacturer declines any liability for failure to observe these safety instructions, for inappropriate use of the appliance or incorrect setting of controls.

⚠ Very young children (0-3 years) should be kept away from the appliance. Young children (3-8 years) should be kept away from the appliance unless continuously supervised. Children from 8 years old and above and persons with reduced physical, sensory or mental capabilities or lack of experience and knowledge can use this appliance only if they are supervised or have been given instructions on safe use and understand the hazards involved. Children must not play with the appliance. Cleaning and user maintenance must not be carried out by children without supervision. Never open the door forcibly or use it as a step.

### PERMITTED USE

⚠ CAUTION: The appliance is not intended to be operated by means of an external switching device, such as a timer, or separate remote controlled system.

⚠ This appliance is intended to be used in household and similar applications such as: staff kitchen areas in shops, offices and other working environments; farm houses; by clients in hotels, motels, bed & breakfast and other residential environments.

⚠ Do not load the machine above the maximum capacity (kg of dry cloth) indicated in the programme table.

⚠ This appliance is not for professional use. Do not use the appliance outdoors.

⚠ Do not use any solvents (e.g. turpentine, benzene), detergents containing solvents, scouring powder, glass or general purpose cleaners, or flammable fluids; do not machine wash fabrics that have been treated with solvents or flammable liquids.

⚠ That the tumble dryer is not to be used if industrial chemicals have been used for cleaning.

⚠ That the lint trap has to be cleaned frequently, if applicable.

⚠ That lint must not to be allowed to accumulate around the tumble dryer.

⚠ Do not dry unwashed items in the tumble dryer.

### INSTALLATION

⚠ The appliance must be handled and installed by two or more persons - risk of injury. Use protective gloves to unpack and install - risk of cuts.

If you want to stack a dryer on top of your washing machine, first contact our After-Sales Service or your specialist dealer to verify whether this is possible.

This is only possible if the dryer is attached to the washing machine by means of appropriate stacking kit available through our After-Sales Service or your specialist dealer.

⚠ Move the appliance without lifting it by the worktop or top lid.

⚠ Installation, including water supply (if any) and electrical connections and repairs must be carried out by a qualified technician. Do not repair or replace any part of the appliance unless specifically stated in the user manual. Keep children away from the installation site. After unpacking the appliance, make sure that it has not been damaged during transport. In the event of problems, contact the dealer or your nearest After-sales Service. Once installed, packaging waste (plastic, styrofoam parts etc.) must be stored out of reach of children - risk of suffocation. The appliance must be disconnected from the power supply before any installation operation - risk of electric shock. During installation, make sure the appliance does not damage the power cable - risk of fire or electric shock. Only activate the appliance when the installation has been completed.

⚠ Do not install your appliance where it may be exposed to extreme conditions, such as: poor ventilation, temperatures below 5 °C or above 35 °C.

⚠ When installing the appliance make sure that the four feet are stable and resting on the floor, adjusting them as required, and check that the appliance is perfectly to level using a spirit level. ⚠ If the appliance is being installed on wood or "floating" floors (certain parquet and laminate materials), secure a 60 x 60 x 3 cm (at least) sheet of plywood to the floor then place the appliance on top of this.

⚠ Connect the water inlet hose(s) to the water supply in accordance with the regulations of your local water company.

⚠ For cold fill only models: do not connect to the hot water supply.

⚠ For models with hot fill: the hot water inlet temperature must not exceed 60 °C.

⚠ The washing machine is fitted with transport bolts to prevent any possible damage to the interior during transport. Before using the machine, it is imperative that the transport bolts are removed. After their removal, cover the openings with the 4 enclosed plastic caps.

⚠ After installation of the device, wait a few hours before starting it so that it acclimates to the environmental conditions of the room.

⚠ Make sure that the ventilation openings in the base of your washing machine (if available on your model) are not obstructed by a carpet or other material.

⚠ Use only new hoses to connect the appliance to the water supply. The old hose-sets should not be reused.

⚠ The supply water pressure must be in the 0.03-1 MPa range.

### ELECTRICAL WARNINGS

⚠ It must be possible to disconnect the appliance from the power supply by unplugging it if plug is accessible, or by a multi-pole switch installed upstream of the socket in accordance with the wiring rules and the appliance must be earthed in conformity with national electrical safety standards.

⚠ Do not use extension leads, multiple sockets or adapters. The electrical components must not be accessible to the user after installation. Do not use the appliance when you are wet or barefoot. Do not operate this appliance if it has a damaged power cable or plug, if it is not working properly, or if it has been damaged or dropped.

⚠ If the supply cord is damaged, it must be replaced with an identical one by the manufacturer, its service agent or similarly qualified persons in order to avoid a hazard - risk of electric shock.

### CLEANING AND MAINTENANCE

⚠ WARNING: Ensure that the appliance is switched off and disconnected from the power supply before performing any maintenance operation; never use steam cleaning equipment - risk of electric shock.



## MATTERS NEED ATTENTION

1. Items that have been soiled with substances such as cooking oil, acetone, alcohol, petrol, kerosene, spot removers, turpentine, waxes and wax removers should be washed in hot water with an extra amount of detergent before being dried in the tumble dryer.
2. Items such as foam rubber (latex foam), shower caps, waterproof textiles, rubber backed articles and clothes or pillows fitted with foam rubber pads should not be dried in the tumble dryer.
3. Fabric softeners, or similar products, should be used as specified by the fabric softener instructions.
4. Remove all objects from pockets such as lighters and matches.
5. **WARNING:** Never stop a tumble dryer before the end of the drying cycle unless all items are quickly removed and spread out so that the heat is dissipated.
6. **WARNING:** The appliance must not be supplied through an external switching device, such as a timer, or connected to a circuit that is regularly switched on and off by a utility.
7. For appliances with ventilation openings in the base, instructions that a carpet must not obstruct the openings.
8. Exhaust air must not be discharged into a flue which is used for exhausting fumes from appliances burning gas or other fuels.
9. The appliance must not be installed behind a lockable door, a sliding door or a door with a hinge on the opposite side to that of the tumble dryer, in such a way that a full opening of the tumble dryer door is restricted.

## DISPOSAL OF PACKAGING MATERIALS

The packaging material is 100% recyclable and is marked with the recycle symbol .

The various parts of the packaging must therefore be disposed of responsibly and in full compliance with local authority regulations governing waste disposal.

## DISPOSAL OF HOUSEHOLD APPLIANCES

This appliance is manufactured with recyclable or reusable materials. Dispose of it in accordance with local waste disposal regulations. For further information on the treatment, recovery and recycling of household electrical appliances, contact your local authority, the collection service for household waste or the store where you purchased the appliance. By ensuring this product is disposed of correctly, you will help prevent negative consequences for the environment and human health.

The symbol  on the product or on the accompanying documentation indicates that it should not be treated as domestic waste but must be taken to an appropriate collection center for the recycling of electrical and electronic equipment.

## INSTALLATION INSTRUCTIONS

### Transport

Transport must be handled by two persons. Two persons should respectively stand on two sides of the washing machine and hold with both hands to transport the washing machine.



### Placing the washing machine correctly

The washing machine must be installed on firm, flat and slip-proof ground. Do not place the washing machine on carpeted or wood covered floor. It is forbidden to place the washing machine on a ground platform and rack.

The washing machine must keep a minimum distance of 10 cm away from the wall or the hard reflector on three sides.

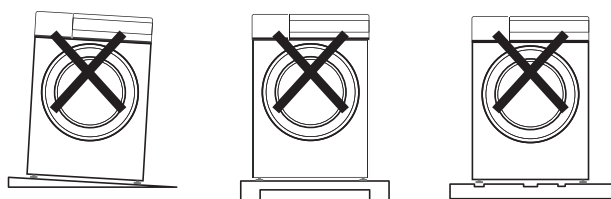

1. On sloping ground 2. On ground platform and rack 3. On uneven ground

## Removing transport bolts and base protector

To protect the washing machine during transport, the internal structure of the washing machine is fastened with four transport bolts. All the transport bolts should be removed before use. (If the bolts are not removed, the washing machine will vibrate vigorously, generate loud noises and function improperly during spinning.)

1. Loosen the transport bolts (four pieces) with a wrench.
2. Shake the bolts left and right to pull them out.
3. Align the bolt covers with the original bolt holes and press until they fit.

- Please keep the transport bolts safe. They are necessary to make a move.
- Do remove the base protector before use, as shown in the figure, or the washing machine will function improperly.

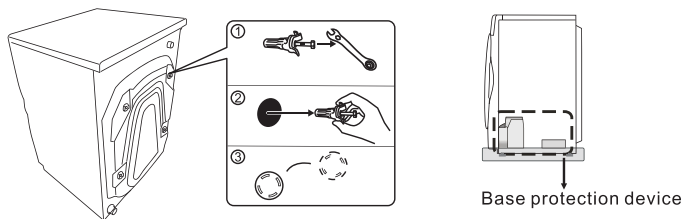

## Level adjustment

If installed on an uneven place, the washing machine will generate abnormal noises or vibrations or function abnormally when in use.

The feet of the washing machine (the four feet are all adjustable) can be adjusted by the following method:

1. Loosen clockwise the locking nuts of the washing machine feet with the wrench and rotate the feet to adjust the height so as to make the washing machine level.
2. When allowed by conditions, use a level meter to check the adjusted state of the washing machine and make calibration when necessary.

Note: all four feet must reliably touch the ground and stand on the ground firmly.

3. Tighten the locking nuts counterclockwise with the wrench to lock the nuts to the bottom of the case.
4. After adjustment, press the diagonal corners of the top cover of the washing machine by a proper force with two hands to confirm that the washing machine is stable.

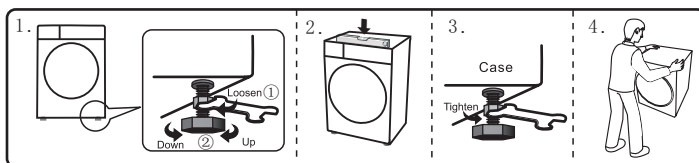



## Connecting the Supply hose

1. Check that sealing washers are firmly seated.
2. Attach the curved end of the hose to the inlet valve of the washing machine, tighten the coupling nuts securely by hand.
3. Attach straight end of the hose to the tap. Tighten the coupling nuts securely by hand.
4. Turn on the taps and check for leaks. Tighten the coupling nuts firmly if there is any leakage. If water pressure is strong, close the water tap completely then open it slightly.

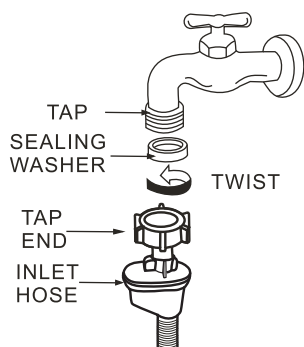

### CAUTION:

- Do not use water which is hotter than 60°C.
- If your faucet is not suitable, please consult your dealer.

## Installing Water Supply Hose to the Washer

Turn the nut clockwise till the nut is tight while holding the hose.

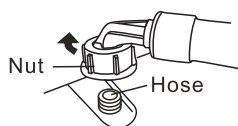

Turn the nut counterclockwise after turning the faucet off if you want to detach the water inlet hose.

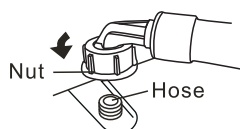

## Connecting the Drain Hose

1. When the machine is not in use, put the drain hose at the back of machine (figure 1).
2. When in operation, install the drain hose into drainage duct (figure 2); you can also put end of drain hose into sewer, leaving space between end of drain hose and sewer elbow to avoid difficulty in draining water out of washing machine.
3. Clean the filter in the pump periodically to keep the washing machine working normally.

Note: Do not take off the drain hose to avoid drainage problems.

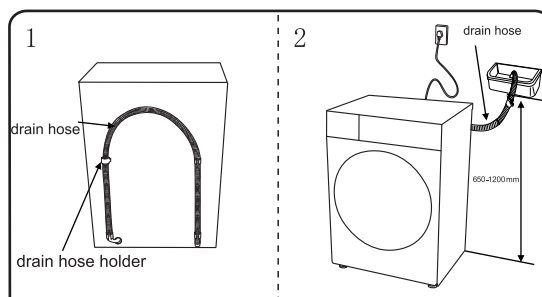

## Specification Sheet

Washing capacity	9.0kg
Spinning capacity	9.0kg
Drying capacity	6.0kg
Max current	10A
Rated voltage	220-240V/50Hz
Rated power	220-240V/1750W
Drying noise	62dB
Washing noise	62dB
Spinning noise	79dB
Water pressure	0.03~1.0MPa
Product dimension (mm)	600x635x850 (Door inclusive) 600x580x850 (Door exclusive)

## PRODUCT DESCRIPTION

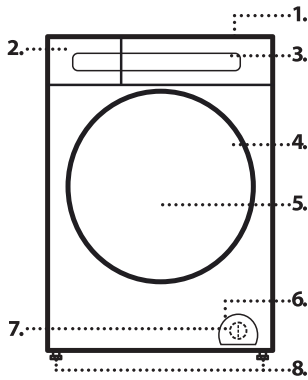

1. Worktop
2. Detergent dispenser
3. Control panel
4. Door handle
5. Door
6. Water filter - behind pump cover
7. Pump cover
8. Adjustable feet (4)

## DETERGENT DISPENSER

### Laundry sanitizer compartment

- The sanitizing liquid is placed in this compartment. It is recommended to use the sanitizing liquid with an ingredient of parachlorometaxylenol. To prevent damage to clothes, the highly concentrated sanitizing liquid should be added according to its instructions.

### Softener compartment

- Fabric softener will be automatically injected into the drum during the final rinse.
- Consumer should follow the softener instructions.

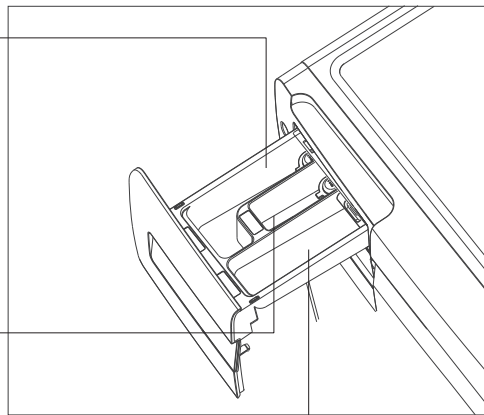

### Main wash compartment

- Detergent for the main wash. For liquid detergent or powder detergent.
- Detergent which is difficult to dissolve, such as powder-shaped soap, should be fully dissolved in advance and then poured into this compartment.

- Special detergent for the front loading washing machine should be used.
- Follow the dosage recommendation. It optimizes the cleaning result, it avoids irritating residues of surplus detergent in your laundry and it saves money by avoiding waste of surplus detergent.
- Detergent should be used according manufacturer's instructions and the type, color, water temperature and degree of stain of the laundry.

## TECHNICAL DATA FOR WATER CONNECTION

### Water connection

Water supply	Cold
Minimum water supply pressure	30 kPa (0.3bar)
Maximum water supply pressure	1000 kPa (10 bar)

## CONTROL PANEL

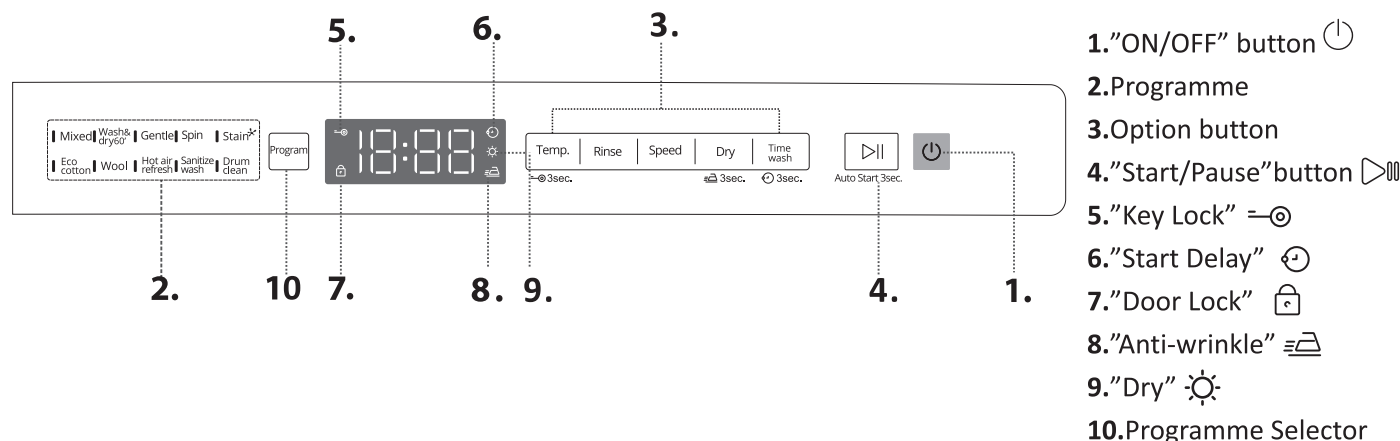

1. "ON/OFF" button
2. Programme
3. Option button
4. "Start/Pause" button
5. "Key Lock"
6. "Start Delay"
7. "Door Lock"
8. "Anti-wrinkle"
9. "Dry"
10. Programme Selector

## PROGRAMMES

For choosing the appropriate programme for your kind of laundry, always respect the instructions on the care labels of the laundry. The value given in the tub symbol is the maximum temperature possible for washing the garment.

### MIXED

- For washing lightly to normally soiled resilient garments in cotton, linen, synthetic fibres and mixed fibres.
- When choosing this programme, you can change the temperature, speed and rinse time.

### WASH & DRY 60'

- For washing and drying cotton and synthetic fibre garments quickly. This cycle washes and dries a laundry load of 1kg in just 60 minutes.
- When choosing this programme, you can not change the temperature, speed and rinse time.

### GENTLE

- For washing particularly delicate garments. Preferably turn garments inside out before washing.
- When choosing this programme, you can adjust the temperature, speed and rinse time.

### SPIN

- Spins the load then empties the water.
- When choosing this programme, you can adjust the speed and rinse time. If user adjust the rinse time, then the function will change to rinse and spin.

### STAIN

- For washing normally to heavily soiled clothing.
- When choosing this programme, you can not change the temperature, speed and rinse time.

### ECO COTTON

- For washing normally soiled cotton garments. At 40°C, this is the standard cotton programme and the most efficient in terms of water and energy consumption.
- When choosing this programme, you can change the temperature, speed and rinse time.

### WOOL

- Wool garments can be washed using programme "Wool" (Machine washable). For best results, use special detergents and do not exceed maximum kg declaration of laundry for this programme.
- When choosing this programme, you can adjust the temperature, speed and rinse time.

### HOT AIR REFRESH

- This programme refreshes garments by removing bad odours and relaxing the fibres with hot air.
- When choosing this programme, you cannot adjust the temperature, speed and the rinse time.
- ⚠ Do not add softener, sanitizer or detergents.

### SANITIZE WASH

- This programme requires you to add laundry sanitizer into its dedicated compartment, which can effectively reduce and prevent bacterial reproduction.
- When choosing this programme, you can adjust the temperature, speed and rinse time.

### DRUM CLEAN

- For drum cleaning only, using high temperature to sterilize the drum to effectively remove dirt and bacteria.
- When choosing this programme, you cannot adjust the temperature, speed and the rinse time.



## OPTIONS

### TEMPERATURE

- Every programme has a predefined temperature. If you want to change the temperature, press the “temperature” button. The value appears on the display.
- Long pressing for 3s to select the child lock function.

### SPEED

- Every programme has a predefined spin speed. If you want to change the spin speed, press the "Speed" button. The value appears on the display.

### TIME WASH

- You can choose various predefined washing time based on your convenience, the operation is flexible and fast.
- When long press time wash button for 3s you can set the end time of the programme. The icon ☺ lights on the display when this function is enabled. To cancel the delayed end, long press the button 3s again.

### RINSE

- By selecting this option, the efficiency of the rinse is increased and optimal detergent removal is guaranteed.
- It is particularly useful for sensitive skin.

### DRY

- This function is used to dry a wet load washed previously in the washer dryer or by hand.
- When this key is pressed, the drying icon ☀ will appear on display.  
Automatic drying:  
In automatic drying mode, the washer dryer machine dries the laundry until the set level of dryness is reached.  
Timed-drying: To dry without wash cycle, you first choose Spin cycle and press Dry button to spin & dry your clothes. You can adjust drying time from 30 min to 4h.
- Refer to programme chart (pg.9) for wash programmes that can add drying function.  
⚠ Always allow a cooling down period after drying before opening the door.

### ANTI-WRINKLE

≡ 3sec.

- This option removes odours and helps to dewrinkle the laundry. After the wash cycle ends, the washing machine will perform gentle tumbling through slow rotations of the drum. You can cancel the anti-wrinkle function by pressing the “Anti-wrinkle” button before the operation starts, or you can interrupt it anytime by pressing the ⏻ button.

## FUNCTIONS

### ON/OFF

- To switch on the washing machine: press the ⏻ button.
- To switch off the washing machine after programme end, long press the ⏻ button until the lights go off.
- To save energy, if the washer dryer is not switched off manually with the button, it turns off automatically approximately 10 minutes after the end of the programme.

### START/PAUSE

- To start the programme, after you have finished your settings. To pause a running programme. To continue a paused programme.
- Long press 3s will activate Auto Start programme from shutdown mode. The max. wash load is 7kg. To add dry function, you can press 'Dry' button. This programme has a predefined wash programme, you can only adjust speed & rinse times.

⚠ Not recommended for wool or silk garments.

### PROGRAMME SELECTION

- After the washing machine is powered on, you can select the desired wash or dry programme depending on the load and stain level.
- Long press the programme key allows to select the desired programme in a skipping way.

### CHILD LOCK

- You can activate the child lock function to prevent unintentional changes to programmes, especially with children near the machine. Both the door and programme buttons will be locked automatically. Door will be unlocked once this function has been deactivated.
- Turn on machine and press “temperature” button for 3 seconds till the buzzer sounds. The child lock function is activated. Repeat steps to deactivate.

### ADD CLOTHES FUNCTION

- As long as a wash programme is running, the door remains locked. To open the door while a programme is in progress, press the “Start/Pause” button. Provided the water level and/or temperature is/are not too high (below 50 °C), the “Add” indicator lights up and you can open the door. For example to add/ remove laundry. Press the “Start/Pause” button again to continue the programme.
- Forcing the door to open may cause parts damage or injury.

## PROGRAMME CHART

Programme	Temperatures		Rinse	Max Spin Speed (rpm)	Max Wash Load (kg)	Max Dry Load (kg)	Dry Function	Programme Time*	Time wash	Anti-Wrinkle	Detergents & Additives		
	Setting	Range			9kg	6kg					Laundry sanitizer	Main wash	Softener
Mixed	30°C	☼ - 60°C	Default:2 Range: 0-6	1400	7	6	✓	1:02	✓	✓	-	✓	✓
Eco cotton	40°C	☼ - 60°C	Default:3 Range: 0-6	1400	9	6	✓	5:13	-	-	-	✓	✓
Wash & dry60'	☼	-	Default:1	1400	1	1	-	1:00	-	-	-	✓	✓
Gentle	30°C	☼ - 40°C	Default:3 Range: 0-6	1000	4	2	✓	1:31	✓	✓	-	✓	✓
Spin	-	-	Default:0 Range: 0-6	1400	9	6	✓	0:11	✓	✓	-	-	✓**
Stain	40°C	-	Default:2	800	4	3.5	✓	1:30	-	✓	-	✓	✓
Wool	☼	☼ - 40°C	Default:2 Range: 0-6	800	2	-	-	1:04	✓	✓	-	✓	✓
Hot air refresh	-	-	-	-	-	3	-	0:45	-	-	-	-	-
Sanitize Wash	40°C	40 - 90°C	Default:2 Range: 0-6	1400	7	5	✓	1:47	✓	✓	✓	✓	✓
Drum Clean	90°C	-	Default:1	800	0	0	✓	2:48	-	-	-	✓	✓

✓\*\* When you adjust rinse times, you can add softener.

Test wash cycle in compliance with regulation AS/NZS 2040.2: set programme "Eco Cotton 40°C, 1400rpm" and drying test in compliance with AS/NZS 2442.2 set programme "Spin + Dry(A)".

\* This data may differ in your home due to changing conditions in inlet water temperature, water pressure etc.

Approximate programme duration values refer to the default setting of the programmes, without options.

## DOOR

To open the door, pull the handle.

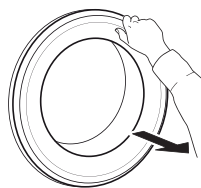

To close the door, hold the handle and push so that you can hear it click shut.

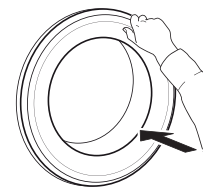

# HOW TO USE THE APPLIANCE

## ACCESSORIES

Contact our After-Sales Service to check if the following accessories are available for your washing machine (and dryer) model

### STACKING KIT SHELF

By which your dryer can be fixed on top of your washing machine to save space and to facilitate loading and unloading your dryer in the higher position.

## DAILY USE

### PREPARING THE LAUNDRY



#### Empty pockets

- Coins, paper clips, etc. could damage the load and the washing machine components.
- Tissues will break down during the wash cycle, and the fragments will have to be subsequently removed by hand.



#### Close all zippers, buttons, and hooks. Tie all ribbons or belts

- Insert the smaller garments (e.g. nylon hosiery, belts, etc.) and garments with hooks (e.g. braziers) into a fabric bag or a pillowcase with a zipper. Remove any rings from curtains, or else place the curtains inside a fabric bag together with the rings.



### Fabric type / Symbol on the wash label

- Cottons, mixed fibres, easy care/synthetics, wool, handwash items.
- Colour  
Separate coloured and white items. Wash new coloured articles separately.
- Size  
Wash items of different sizes in the same wash load, to improve washing efficiency and distribution of the articles in the drum.
- Delicates  
Wash delicate items separately; they require gentle treatment.

### HOW TO USE THE WASHING MACHINE

#### 1. Load laundry



Open the door and load the laundry. Load the articles one at a time loosely into the drum, without overfilling. Observe the load sizes given in the "PROGRAMME CHART" table. Overloading the machine will result in unsatisfactory washing results and creased laundry

#### 2. Close door





Make sure that no laundry gets stuck between door glass and rubber seal. Close the door so that you can hear it click shut.

#### 3. Open water tap



Make sure that the washing machine is connected to the water mains. Open the water tap.

#### Switch on washing machine

Press the "ON/OFF" , the "Start/Pause"  lamp flashes slowly. The programme setting which you used last will appear on the control panel.

#### 4. Set the desired programme

Select the required programme with the "Programme" button. The display will show the duration of the cycle. Adjust the temperature and/or spin speed settings if needed with the relative buttons.

#### Change temperature, if needed

Press "Temp" button once, for the programme default temperature to be displayed on screen. Press "Temp" again to switch the temperature within temperature range.

#### Change spin speed, if needed

Press "Speed" button once, default speed display on screen. Continue to press "Speed" button, speed increasing to maximum. Press "Speed" again, minimum speed display on screen. Continue to press "Speed" button to increase speed continuously.

#### Change rinse times, if needed

Press "Rinse" button once, default rinse time display on screen. Continue to press "Rinse" button, rinse time increasing to maximum. Press "Rinse" again, nothing display on screen, to show rinse time zero. Continue to press "Rinse" button to increase rinse time continuously.

#### Change the wash duration, if needed

Press the "Time wash" button, for the programme default time to be displayed on screen. Press "Time wash" again to switch the duration within duration range.

#### Select options, if needed

Press the button to select the option. The programme parameter will be displayed on the screen.

 If the selected option is incompatible with the programme set, the incompatibility will be signalled by a buzzer (2 beeps)



## 5. Add detergent



Pull out the detergent dispenser and add detergent (and additives/softener) into the relative compartments as described in section "DETERGENT DISPENSER". Observe the dosing recommendations on the detergent pack.

Correct dosing of detergent / additives is important, because:

- it optimizes the cleaning result
- it avoids irritating residues of surplus detergent in your laundry
- it saves money by avoiding waste of surplus detergent
- it protects the washing machine by avoiding calcification of components
- it respects the environment by avoiding unnecessary environmental burden.

## 6. Delaying the ending time of a programme

- When long press time wash button for 3s you can set the end time of the programme.

## 7. Start programme

- The LED light at the left side will turn on after the user selects the programme, then pressing the "▶||" the door will be locked.
- To avoid overflow, do not open the detergent dispenser during a running programme.
- The remaining programme duration which is indicated on the display can vary. Factors like unbalance in the wash load, or foam formation, can have an effect on the programme duration.

## 8. Change the settings of a running programme, if needed

You can still change the settings while a programme is running.

To change the settings of a running programme:

- Press "Start/Pause" ▶|| to put the running programme on pause.
- Change your settings.
- Press "Start/Pause" ▶|| again to continue the programme.

If you have changed the programme, do not add detergent for the new programme.

To prevent that a running programme is changed by accident (for instance by children), use the "Key lock" —○ (see section "FUNCTIONS").



## Pause a running programme and open the door, if needed

- Press "Start/Pause" ▶|| to pause a running programme.
- Provided water level is not too high, water temperature below 50°C. the  lights off, you can open the door, for example to add more laundry, or to remove laundry which was loaded by mistake.
- Press "Start/Pause" ▶|| to proceed with the programme.

## 9. Cancelling a running programme, if needed





- Press and hold the "ON/OFF"  button until the washing machine stops.
- If the water level and temperature are low enough, the door unlocks and may be opened.
- The door remains locked if there is water in the drum. To unlock the door, switch the washing machine on, select the spin programme and turn the spin option off by setting the spin speed to "- -"
- The water is emptied and the door unlocks at the end of the programme.

## 10. Switch off the washing machine after programme End

- At the end of the cycle, after the washing cycle ends, in the default state, the washing machine buzzes to prompt user. If the buzzer prompt is not required the setting can be canceled (press "ON/OFF" button, after confirming that the machine is powered on, long press "Start/Pause" button, when you hear the prompt tone for the second time, the buzzer prompt is canceled).
- The door can only be opened when the  lights off.
- Check that the door unlocked symbol is lit, then open the door and take out the laundry.
- Press "ON/OFF"  to switch the washing machine off.

To save energy, if the washing machine is not switched off manually with the button, it turns off automatically approximately 10 minutes after the end of the programme. Leave the door ajar to let the interior of the washing machine dry.

## INDICATORS

	Child Lock	This indicator will lights up: Child lock function activated, all buttons (except for power button) locked.
	Anti-wrinkle	This indicator will lights up: Anti wrinkle function activated.
	Delay end	This indicator will lights up: Delay end function activated.
	Dry	This indicator will lights up: Dry function activated.
	Door lock	This indicator will lights up: 1. Machine is running a programme. 2. High Temperature in drum. 3. High Water level.
<b>Add</b>	Add clothes	This indicator will lights up: Door can be opened to add or remove clothes.





## HINTS AND TIPS

### RULES FOR SEPARATING LAUNDRY

- Fabric type / indications on label (cotton, mixed fibres, synthetic, wool, handwash items)
- Colour (separate coloured garments from whites, wash new coloured items separately)
- Size (wash items of different sizes in the same load to improve washing efficacy and weight distribution in the drum)
- Delicates (place small items – such as nylon stockings – and garments with clasps – such as braziers – in a laundry bag or in a pillow case with a zip).

### WASH SYMBOLS ON GARMENT LABELS

The value given in the tub symbol is the maximum temperature possible for washing the garment.

-  Normal mechanical action
-  Reduced mechanical action
-  Much reduced mechanical action
-  Hand wash only
-  Do not wash

### CLEAN THE WATER FILTER REGULARLY

- This is needed to prevent the filter from blocking and preventing the water from draining correctly.

### SAVING ENERGY AND PROTECTING THE ENVIRONMENT

- Keeping within the load limits indicated in the “PROGRAMME CHART” will optimise energy, water and detergent consumption and reduce washing times.
- Do not exceed the detergent quantities recommended by the detergent manufacturer.
- Save energy by using a 60 °C instead of a 90 °C wash programme, or by using a 40 °C instead of a 60 °C wash programme. We recommend using “Eco Cotton” programme, which is longer, but uses less energy.
- To save energy and time when washing, select highest spin speed available for the programme to reduce the residual water remaining in the garments at the end of the wash cycle.
- Pretreat any stains with an appropriate stain remover, or else dampen any dried-on stains with water prior to washing, as this will reduce the need to use a high temperature watch programme.
- Wash&dry 60<sup>1</sup> programme applicable to quick washing and drying of a few clothes with few stains.

## CLEANING & MAINTENANCE

**For any cleaning and maintenance, switch off and unplug the washing machine.  
Do not use flammable fluids to clean the washing machine.**

### CLEANING THE OUTSIDE OF THE WASHING MACHINE

Use a soft damp cloth to clean the outer parts of the washing machine.

Do not use glass or general purpose cleaners, scouring powder or similar to clean the control panel – these substances might damage the printing.

### CHECKING THE WATER SUPPLY HOSE

Check the inlet hose regularly for brittleness and cracks. If damaged, replace it by a new hose available through our After-Sales Service or your specialist dealer.

Depending on the hose type:

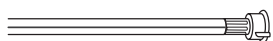
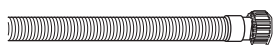

If the inlet hose has a transparent coating, periodically check if the colour intensifies locally. If yes, the hose may have a leak and should be replaced.

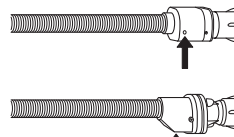

For water stop hoses: check the small safety valve inspection window (see arrow). If it is red, the water stop function was triggered, and the hose must be replaced by a new one. For unscrewing this hose, press the release button (if available) while unscrewing the hose.



## CLEANING THE MESH FILTERS IN THE WATER SUPPLY HOSE

1. Close water tap and unscrew the inlet hose.

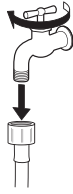

2. Clean the mesh filter at the hose's end carefully with a fine brush.



3. Now unscrew the inlet hose on the back of the washing machine by hand. Pull out the mesh filter from the valve on the back of the washing machine with pliers and carefully clean it.

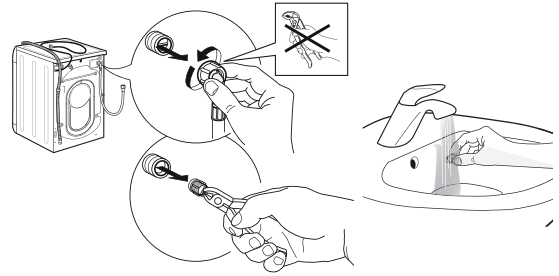

4. Insert the mesh filter again. Connect the inlet hose to water tap and washing machine again. Do not use a tool to connect the inlet hose. Open the water tap and check that all connections are tight.

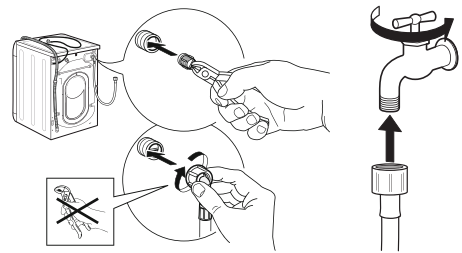

## CLEANING THE DETERGENT DISPENSER

1. Remove the detergent dispenser by pressing on the release button and at the same time pulling out the detergent dispenser.

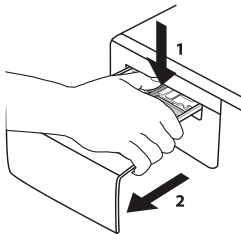

2. Remove the insert from the softener compartment.

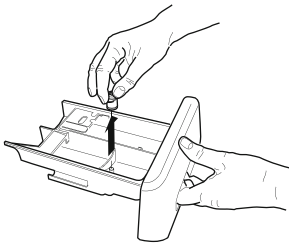

3. Clean all parts under running water, removing all detergent or softener residues.

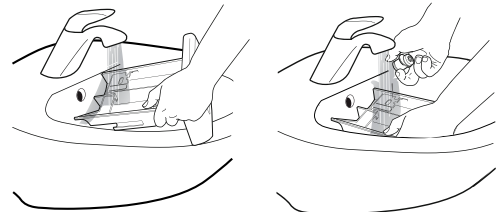

4. Wipe the parts dry with a soft cloth.



5. Reinstall the detergent dispenser and push it back into the detergent compartment.

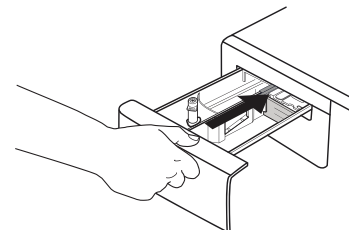

## CLEANING THE WATER FILTER / DRAINING RESIDUAL WATER

**Switch off and unplug the washing machine before cleaning the water filter or draining residual water. If you used a hot wash programme, wait until the water has cooled down before draining any water. Clean the water filter regularly, to avoid that the water cannot drain after the wash due to obstruction of the filter. If the water cannot drain, the display indicates that the water filter may be clogged.**

### Cleaning the drain pump filter / draining residual water

1. Power Off and unplug the washing machine from the electrical outlet.
2. Gently press the top area of the filter cover to open.

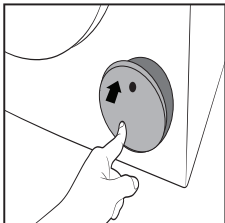

3. Place a container close to the pump to collect any spillage.
4. Stretch the "emergency drain hose" to the container.

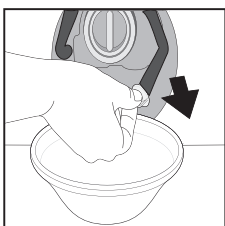

5. When the container is full with water, plug the stopper to the hose end and empty the container. Repeat this procedure until no more water flows out. Afterwards firmly close the emergency drain hose with the stopper and reinsert the hose in the washing machine's base.

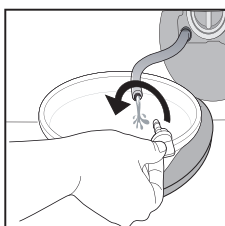

6. **Remove filter:** Lay a cotton cloth beneath the drain pump filter, which can absorb a small amount of water. Then remove the drain pump filter by turning it out anticlockwise.

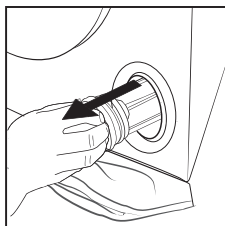
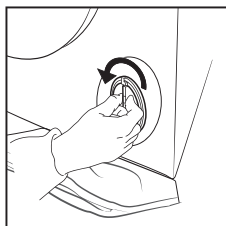

7. Clean the drain pump filter: remove residues in the filter and clean it under running water.
8. Insert the drain pump filter: Reinsert the drain pump filter again by turning it in clockwise direction. Make sure to turn it in as far as it goes; the filter handle must be in vertical position. To test water tightness of the drain pump filter, you can pour about 1 liter of water into the detergent dispenser.

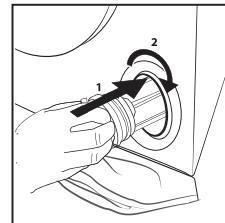

## TROUBLESHOOTING

The washing dryer machine may sometimes not work properly for certain reasons. Before calling the Support Centre, it is recommended to check to see if the problem can be easily resolved using the following list.

Anomalies	Possible causes / Solution
The washer dryer does not turn on.	<ul style="list-style-type: none"> <li>• The plug is not inserted into the electrical outlet, or not enough to make contact.</li> <li>• There has been a power failure. Press the ON/OFF button to reset programme.</li> <li>• The door is not fully closed.</li> </ul>
The wash cycle does not start.	<ul style="list-style-type: none"> <li>• The ON/OFF button has not been pressed.</li> <li>• The START/PAUSE button has not been pressed.</li> <li>• The water tap is not open.</li> <li>• A start delay has been set.</li> </ul>
The washer dryer does not fill with water.	<ul style="list-style-type: none"> <li>• The water intake hose is not connected to the tap.</li> <li>• The hose is bent.</li> <li>• The water tap is not open.</li> <li>• The mains water supply has been shut off.</li> <li>• There is not enough pressure.</li> </ul>
The washer dryer loads and drains water continuously.	<ul style="list-style-type: none"> <li>• The START/PAUSE button has not been pressed.</li> <li>• The drain hose has not been installed at 65 to 120 cm from the ground.</li> <li>• The end of the drain hose is immersed in water.</li> <li>• The drain connector on the wall does not have an air vent.</li> </ul> <p>If the problem persists after having performed these checks, close the water tap, shut off the washer dryer, and call the Support Centre. If the dwelling is located on one of the uppermost floors of a building, a siphon effect can sometimes occur, thus causing the washer dryer to load and drain water continuously. Special anti-siphon valves are available on the market to prevent these types of problems.</p>
The washer dryer does not drain or does not spin.	<ul style="list-style-type: none"> <li>• The programme does not include the draining function: with certain programmes it must be activated manually.</li> <li>• The drain hose is bent.</li> <li>• The drain line is obstructed.</li> </ul>
The washer dryer vibrates excessively during the spin cycle	<ul style="list-style-type: none"> <li>• At the time of installation, the drum was not properly unlocked.</li> <li>• The washer dryer is not level.</li> <li>• The washer dryer is squeezed between furniture and the wall.</li> </ul>
The washer dryer leaks water.	<ul style="list-style-type: none"> <li>• The water intake hose has not been tightened properly. Please check your hose regularly and in case of any damage or leakage have it replaced.</li> <li>• The detergent dispenser is clogged.</li> <li>• The drain hose has not been properly fastened.</li> </ul>
The display shows an error code.	<ul style="list-style-type: none"> <li>• Shut off the machine, disconnect the plug from the outlet, and wait about 1 minute before turning it back on. If the problem persists, call the Support Centre.</li> </ul>
Too much foam is formed.	<ul style="list-style-type: none"> <li>• The detergent is not compatible with the washer dryer (it must bear the wording "for washing machines", "for hand washing and washing machines", or something similar).</li> <li>• The dosage was excessive.</li> </ul>
The washer dryer does not dry.	<ul style="list-style-type: none"> <li>• The plug is not inserted into the electrical outlet.</li> <li>• There has been a power failure. Press the ON/OFF button to reset programme.</li> <li>• The door is not fully closed.</li> <li>• A start delay has been set.</li> <li>• The DRY function is set to its 0 position.</li> </ul>
Abnormal sound during spin	<ul style="list-style-type: none"> <li>• The power cord or other objects touch the cabinet.</li> <li>• Transport bolts have not been removed.</li> <li>• Foreign objects such as coins or hairpins are in the drum.</li> </ul>



Fault code	Description	Possible causes	Solution
No display	out of operation	<ul style="list-style-type: none"> <li>● Whether the outlet have electricity</li> <li>● Whether the plug is plugged in power cut or not</li> <li>● Whether there is a power failure</li> <li>● Whether the fuse has blown in the mains plug</li> </ul>	
E11	No water	<ul style="list-style-type: none"> <li>● Tap turn on/off?</li> <li>● Whether the water inlet hose is frozen</li> <li>● Whether the mesh filter is clogged</li> <li>● Water stopped or not</li> </ul>	Press the Start/ Pause button
E12	undrained	<ul style="list-style-type: none"> <li>● Ensure the drain pipe in the right place</li> <li>● Drain height too high or not</li> <li>● Whether the drain hose is blocked</li> <li>● Ensure the drain-pipe length</li> </ul>	Press Start/Pause Button
H	Door can't be opened	<ul style="list-style-type: none"> <li>● Make sure don't use hot water</li> <li>● The water temperature or water level is high when washing</li> </ul>	Automatic unlocking Until the temperature drops to safety
U3	No dehydration	<ul style="list-style-type: none"> <li>● Ensure the machine is level</li> <li>● Avoid overloading with few single heavy items</li> <li>● Avoid rolling blanket up into machine</li> </ul>	Add 2 pieces of cloth and Press the Start/pause
U4	Door not closed		Close the door, until the "locked" light on, confirm it then press "Start/Pause" to reoperation
Other code	Alarm		Press "Start/Pause" to reoperation, If still can't solve the problem, please contact the service center.

## AFTER-SALES SERVICE

### BEFORE CALLING THE AFTER-SALES SERVICE

1. See if you can solve the problem by yourself with the help of the suggestions given in the **TROUBLESHOOTING**
2. Switch the appliance off and back on again to see if the fault persists.

### IF AFTER THE ABOVE CHECKS THE FAULT STILL OCCURS, GET IN TOUCH WITH THE NEAREST AFTER-SALES SERVICE

When contacting our Client After-sales service, always specify:

- a brief description of the fault;
- the type and exact model of the appliance;

- your full address;
- your telephone number.

If any repairs are required, please contact an authorised after-sales service (to guarantee that original spare parts will be used and repairs carried out correctly).

